

ARCHITECTURAL FENESTRATION | WOOD, STEEL & BRONZE  
LUXURY RESIDENTIAL & COMMERCIAL



Oliveri Millworks is a multi-generational family-owned business, producing and supplying the finest quality wood, steel, stainless steel windows and doors.

Operating out of West Palm Beach, Florida since 1981, Oliveri's architectural line of mahogany windows and doors, steel, stainless steel, bronze, interior doors, and custom designs, define the homes they grace. From luxury residential to the top tier commercial projects, Oliveri offers general contractors, architects and designers a partner in making their projects come to life with a solutions based approach.

Oliveri Millworks stays ahead of the competition by offering an extensive line of products with custom elements made possible by advanced CNC technology and extensive testing. We offer split finishes with mixed species of woods & metals, custom finishes, and one-off designer pieces that will meet any unique design specifications.



WWW.OLIVERIMILLWORKS.COM  
3001 TUXEDO AVE WEST PALM BEACH, FL 33405 | 561-478-7233

EXCELLENCE IN THE PALM BEACH TRADITION SINCE 1981

WINDOWS | DOORS | CUSTOM DESIGNS

HURRICANE IMPACT RATED  
BALLISTIC DOORS AND WINDOWS AVAILABLE

EXCELLENCE SINCE 1981



# WOOD EXTERIOR PRODUCT OPTIONS

## WOOD SPECIES

- Ipe
- Teak
- Exotic
- Cypress
- Red Oak
- White Oak
- Mahogany
- Old Growth Cypress
- Accoya - Wood Composite

*\*All cores are mahogany*

## HARDWARE

- Siegenia Multi-Point Systems
- Multi-Point Gears
- Emtek
- FSB
- Fusital
- Hager
- McKinney
- Pemko
- Valli & Valli
- Sun Valley Bronze
- Merit
- Rocky Mountain Hardware
- Emtek
- FSB
- Fusital
- Hager
- Baldwin
- McKinney
- Rockwood
- Pemko
- FPL
- Valli & Valli

\*Other Hardware brands options available, please contact Oliveri Millworks for more options

## FINISHING

All Oliveri windows and doors are completely painted unassembled to allow for finishing in gasket grooves and lock assembly areas, glazed, assembled and final coats are applied.

Oliveri Standard and Custom Colors Available  
Oliveri uses water based finished products only.

## SCREENS

- COLORS:
- Charcoal Gray
  - Light Gray
  - Black
  - White
  - Bronze
  - Custom Available

- MATERIALS:
- Wood
  - Aluminum
  - Removable Fixed
  - Roll Down

## GLAZING

Laminated Insulated Impact Glass  
Annealed, High Strength, or Tempered  
Possible Configurations: 3/16" or 1/4" x .075  
or .090 x 1/2" Spacer x 3/16" or 1/4"

Mono Impact Glass  
Annealed, High Strength, or Tempered  
Possible Configurations: 3/16" or 1/4" x .075  
or .090 x 1/2" Spacer x 3/16" or 1/4"  
Other specs available, Low "E" options  
available, Low iron glass available

Multiple glass configurations, colors and Low-E  
films available. please contact Oliveri Millworks  
for more details

\* Ballistic glass available,  
All colors available



Cypress Limewashed Door



### INSWING & OUTSWING

Available in impact rated in varying shapes and sizes

Sizes up to 76x144  
Design pressure to +80/-80

Radius Top  
French Doors



4'x10' Entry Door



Teak Impact Door

# LIFT & SLIDE



Panel sizes to 5' x 12' Door units to any opening size Design pressures to 60/65  
Pocket configuration available

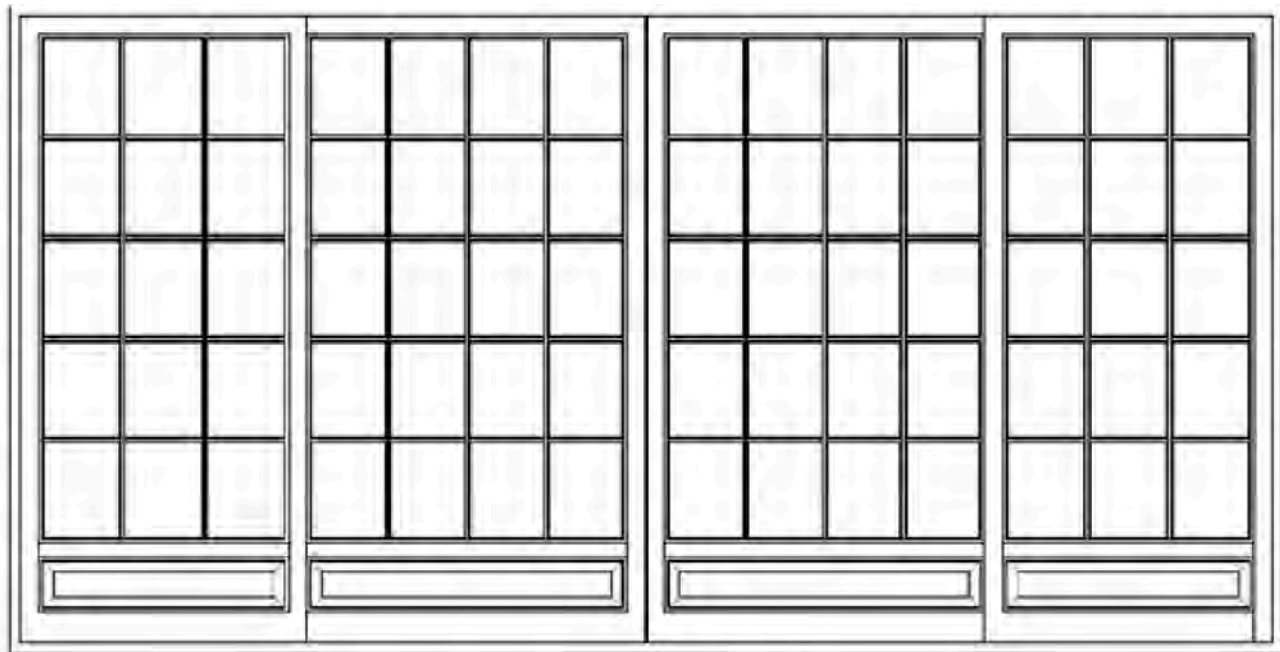

# BI-FOLDING DOORS



Design pressures to 65/65  
Sizes up to 100' +  
Note Miami to 20'  
Height to 10' plus transoms

CONFIGURATIONS

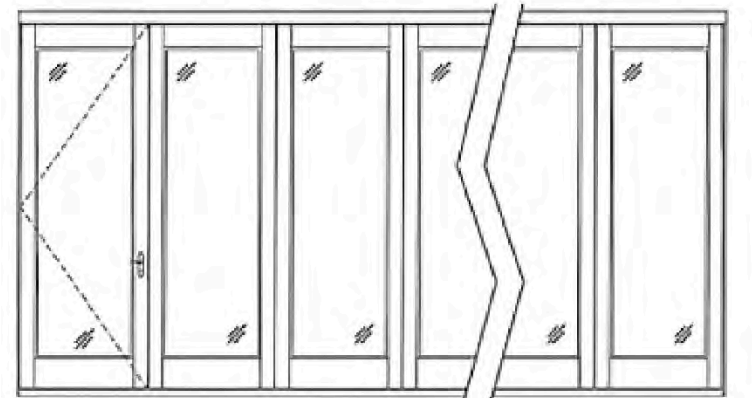
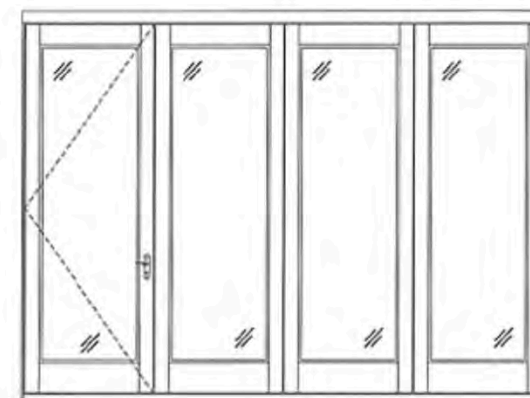
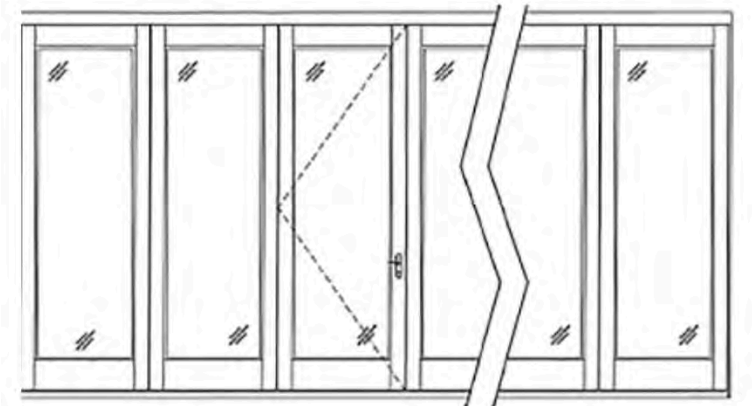

# AWNING AND HOPPER



Awning with French Casement Window



Impact Rated Mahogany Hopper

## CONFIGURATIONS

Sizes up to 80' x 84' Design pressure to 70/70

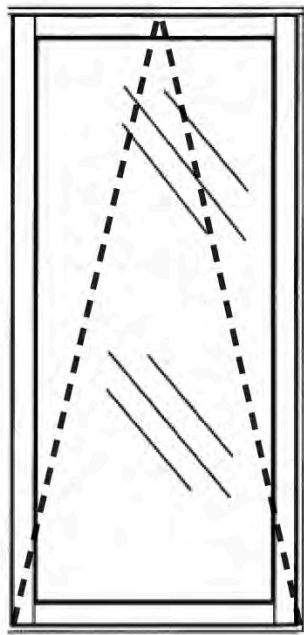

Hopper

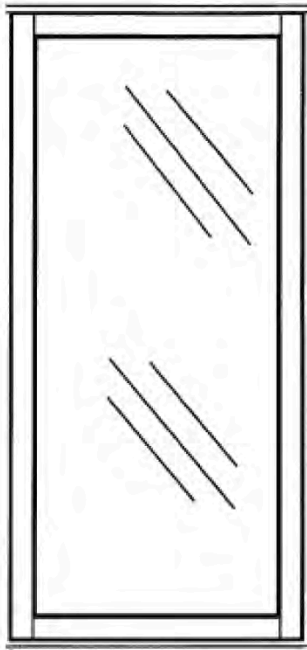

Fixed

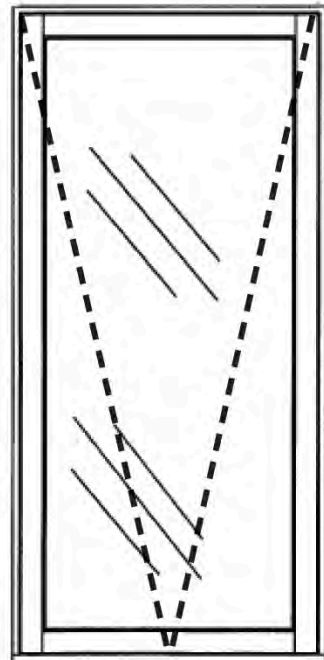

Awning



# CASEMENT WINDOWS



Inswing Tilt & Turn with Sidelights and Transom



Custom Oval Shaped Window

## CONFIGURATIONS

IN SWING | OUT SWING | TILT-TURN | FRENCH CASEMENT

Inswing  
Outswing  
Tilt & Turn  
Radius  
Eyebrow  
Transoms

Concealed Hinge  
Butt Hinge

Tested Design Pressure +75/-75  
Mono and Insulated Glass  
Low E Options

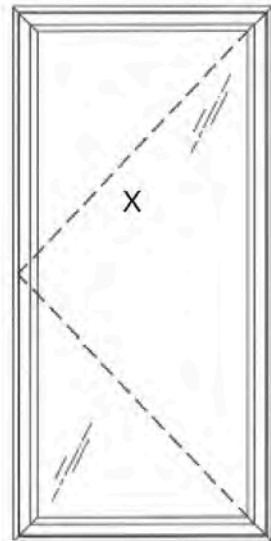

Rectangular

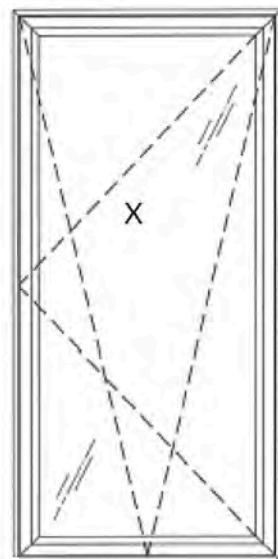

Tilt - Turn

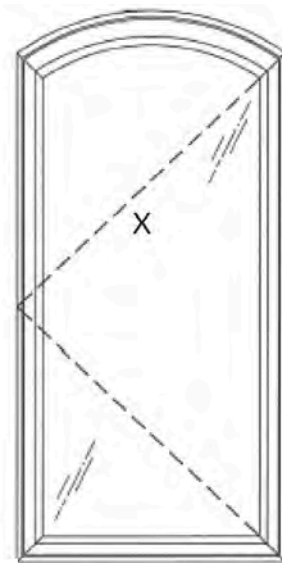

Eyebrow

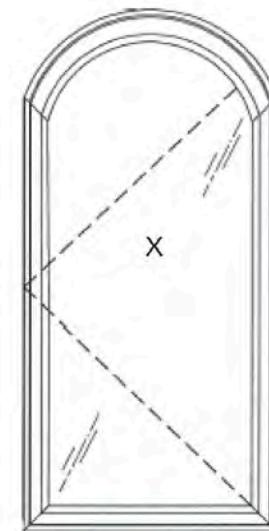

Radius

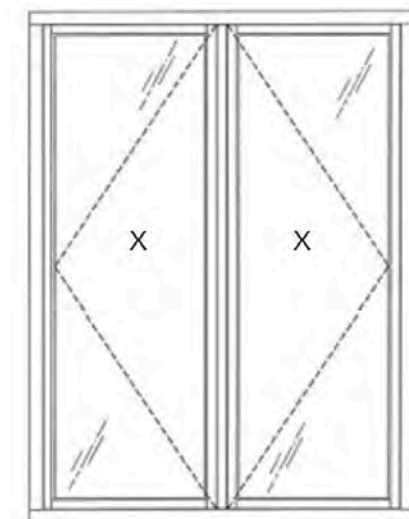

French

# SINGLE/DOUBLE

Oliveri produces a complete line of single, double, and triple hung windows including sash, weight, and chain and balancers.



# TRIPLE HUNG



## CONFIGURATIONS



Rectangle  
4000 Series



Arc  
4000 Series

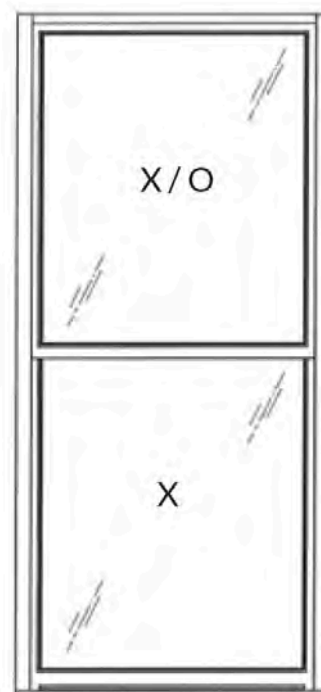

Rectangle  
4500 Series

## AVAILABLE IN SASH WEIGHT OR CHAIN & BALANCERS

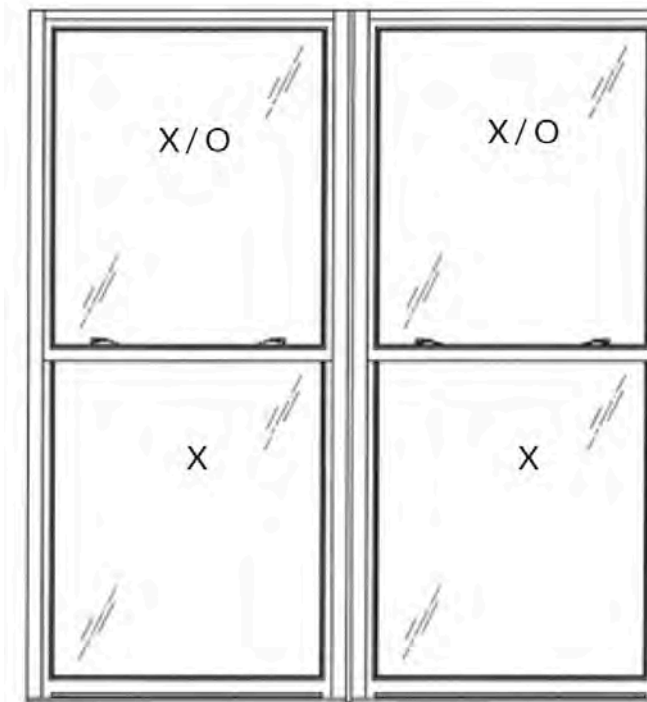

Twin 4500 Series

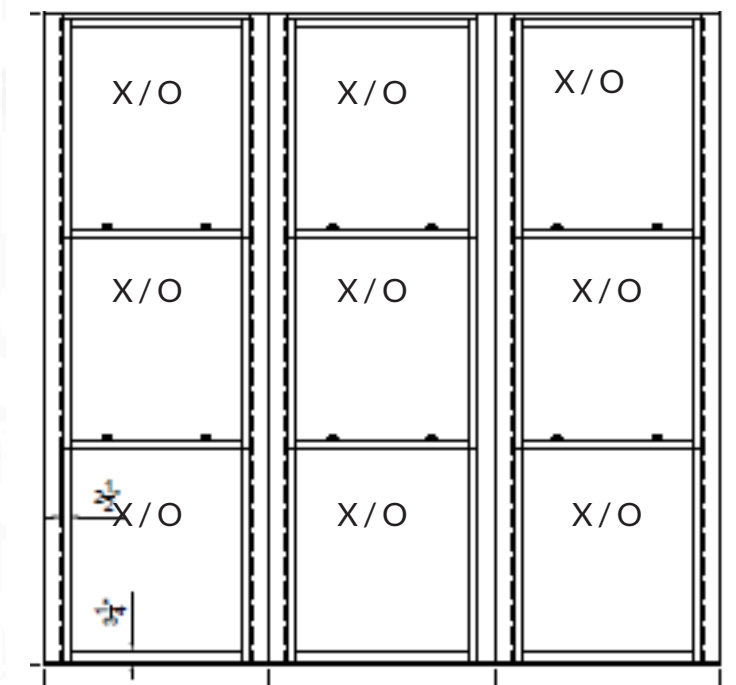

Triple Hung 4500 Series

ANY AND ALL CONFIGURATIONS CAN BE MODIFIED TO MEET DESIGN INTENT

### SINGLE OUTSWING DOORS

NOTE: SHOWN WITH OLIVERI NARROW-LINE CONFIGURATION

PART DESCRIPTION	SIZE
MAX. UNIT WIDTH	50 3/8"
MAX. UNIT HEIGHT	122"
STILES / TOP RAIL	3 1/2"
BOTTOM RAIL	6"
MAX. DESIGN PRESSURE	+60.0   -60.0

### SINGLE INSWING DOORS

NOTE: SHOWN WITH OLIVERI NARROW-LINE CONFIGURATION

PART DESCRIPTION	SIZE
MAX. UNIT WIDTH	50 3/8"
MAX. UNIT HEIGHT	121 1/2"
STILES / TOP RAIL	3 1/2"
BOTTOM RAIL	6"
MAX. DESIGN PRESSURE	+60.0   -60.0

### FRENCH OUTSWING DOORS

NOTE: SHOWN WITH OLIVERI NARROW-LINE CONFIGURATION

PART DESCRIPTION	SIZE
MAX. UNIT WIDTH	99 1/2"
MAX. UNIT HEIGHT	122"
STILES / TOP RAIL	3 1/2"
BOTTOM RAIL	6"
MAX. DESIGN PRESSURE	+60.0   -60.0

### FRENCH INSWING DOORS

NOTE: SHOWN WITH OLIVERI NARROW-LINE CONFIGURATION

PART DESCRIPTION	SIZE
MAX. UNIT WIDTH	99 1/2"
MAX. UNIT HEIGHT	121 1/2"
STILES / TOP RAIL	3 1/2"
BOTTOM RAIL	6"
MAX. DESIGN PRESSURE	+60.0   -60.0

### INSWING/OUTSWING WITH SIDELITES AND TRANSOMS

NOTE: SHOWN WITH OLIVERI NARROW-LINE CONFIGURATION

SIDELITE PORTION		DOOR PORTION	
PART DESCRIPTION	SIZE	PART DESCRIPTION	SIZE
MAX. UNIT WIDTH	50 3/8"	MAX. UNIT WIDTH	99 1/2"
MAX. UNIT HEIGHT	122"	MAX. UNIT HEIGHT	122"
STILES / TOP RAIL	3 1/2"	STILES / TOP RAIL	3 1/2"
BOTTOM RAIL	6"	BOTTOM RAIL	6"
MAX. DESIGN PRESSURE	+60.0   -60.0	MAX. DESIGN PRESSURE	+60.0   -60.0

### ARCH TOP INSWING/OUTSWING WITH SIDELITES AND TRANSOMS

SIDELITE PORTION		DOOR PORTION	
PART DESCRIPTION	SIZE	PART DESCRIPTION	SIZE
MAX. UNIT WIDTH	50 3/8"	MAX. UNIT WIDTH	99 1/2"
MAX. UNIT HEIGHT	122"	MAX. UNIT HEIGHT	122"
STILES / TOP RAIL	3 1/2"	STILES / TOP RAIL	3 1/2"
BOTTOM RAIL	6"	BOTTOM RAIL	6"
MAX. DESIGN PRESSURE	+60.0   -60.0	MAX. DESIGN PRESSURE	+60.0   -60.0

### BI-FOLDING PANEL SYSTEM #1

PART DESCRIPTION	SIZE
MAX. UNIT WIDTH	340 3/4"
MAX. UNIT HEIGHT	126 1/4"
STILES / TOP RAIL	5"
BOTTOM RAIL	8 1/2"
MAX. DESIGN PRESSURE	+55.0   -55.0

### BI-FOLDING PANEL SYSTEM #2

PART DESCRIPTION	SIZE
MAX. UNIT WIDTH	171 1/4"
MAX. UNIT HEIGHT	126 1/4"
STILES / TOP RAIL	5"
BOTTOM RAIL	8 1/2"
MAX. DESIGN PRESSURE	+50.0   -50.0

### LIFT AND SLIDE DOOR SYSTEM

240" MAX. FRAME IN MIAMI (UNLIMITED MULTIPLE UNITS IN HORIZONTAL DIRECTION ALLOWED OUTSIDE OF MIAMI)

PART DESCRIPTION	SIZE
MAX. UNIT WIDTH	240"
MAX. UNIT HEIGHT	144"
STILES / TOP RAIL	4"
BOTTOM RAIL	8 3/4"
MAX. DESIGN PRESSURE	+60.0   -65.0

### LIFT AND SLIDE DOOR SYSTEM WITH POCKET

238" OVERALL UNIT WIDTH

PART DESCRIPTION	SIZE
MAX. UNIT WIDTH	238 7/8"
MAX. UNIT HEIGHT	144"
STILES / TOP RAIL	4"
BOTTOM RAIL	8 3/4"
MAX. DESIGN PRESSURE	+60.0   -65.0

ANY AND ALL CONFIGURATIONS CAN BE MODIFIED TO MEET DESIGN INTENT

INSWING/OUTSWING FRENCH CASEMENT WINDOWS

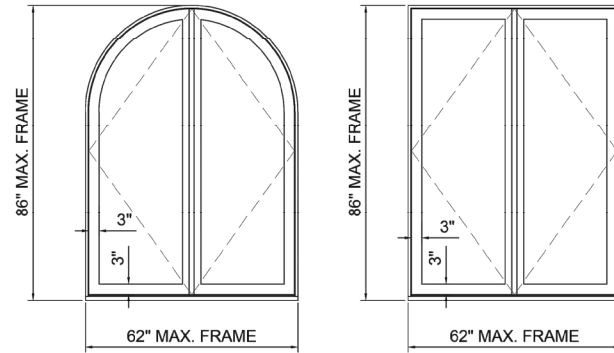

PART DESCRIPTION	SIZE
MAX. UNIT WIDTH	62"
MAX. UNIT HEIGHT	86"
STILES / TOP RAIL	3"
BOTTOM RAIL	3"
MAX. DESIGN PRESSURE	+75.0   -75.0

OUTSWING SINGLE CASEMENT WINDOWS

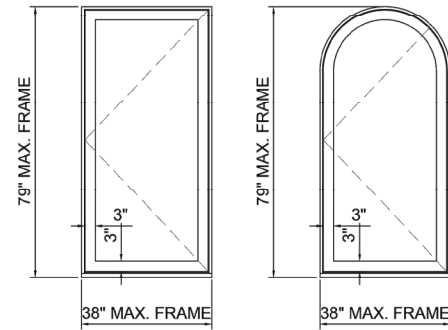

PART DESCRIPTION	SIZE
MAX. UNIT WIDTH	38"
MAX. UNIT HEIGHT	79"
STILES / TOP RAIL	3"
BOTTOM RAIL	3"
MAX. DESIGN PRESSURE	+75.0   -75.0

INSWING/TILT&TURN SINGLE CASEMENT WINDOWS

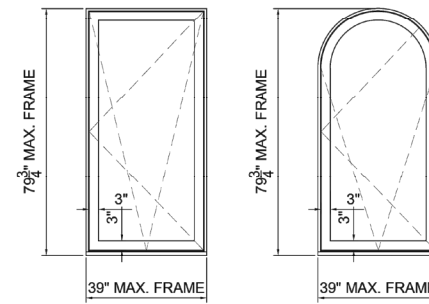

PART DESCRIPTION	SIZE
MAX. UNIT WIDTH	39"
MAX. UNIT HEIGHT	79 3/4"
STILES / TOP RAIL	3"
BOTTOM RAIL	3"
MAX. DESIGN PRESSURE	+75.0   -75.0

INSWING/OUTSWING TWIN CASEMENT WINDOWS

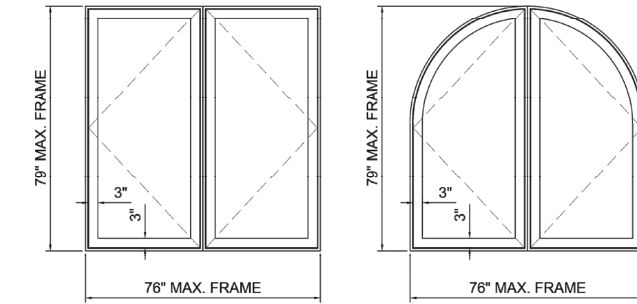

PART DESCRIPTION	SIZE
MAX. UNIT WIDTH	76"
MAX. UNIT HEIGHT	79"
STILES / TOP RAIL	3"
BOTTOM RAIL	3"
MAX. DESIGN PRESSURE	+75.0   -75.0

NOTES: EYEBROW TOP WINDOWS AVAILABLE AS WELL

DOUBLE-HUNG SASH WEIGHT AND CHAIN WINDOWS

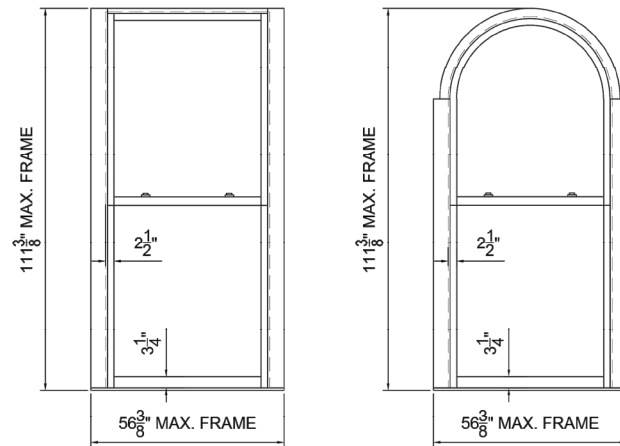

PART DESCRIPTION	SIZE
MAX. UNIT WIDTH	56 3/8"
MAX. UNIT HEIGHT	111 3/8"
STILES / TOP RAIL	2 1/2"
BOTTOM RAIL	3 1/4"
MAX. DESIGN PRESSURE	+60.0   -65.0

DOUBLE-HUNG BALANCE WINDOWS

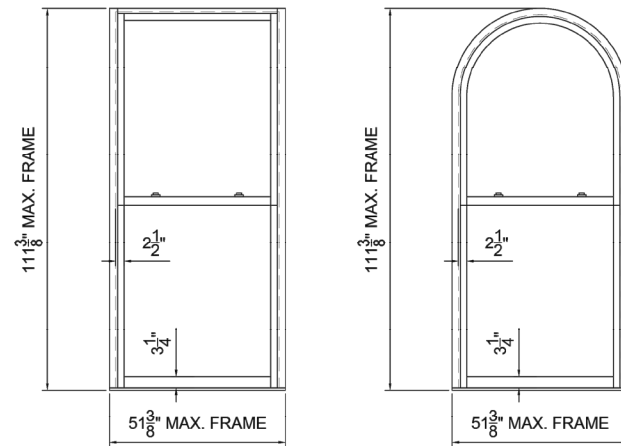

PART DESCRIPTION	SIZE
MAX. UNIT WIDTH	51 3/8"
MAX. UNIT HEIGHT	111 3/8"
STILES / TOP RAIL	2 1/2"
BOTTOM RAIL	3 1/4"
MAX. DESIGN PRESSURE	+60.0   -65.0

TWIN DOUBLE-HUNG BALANCE WINDOWS

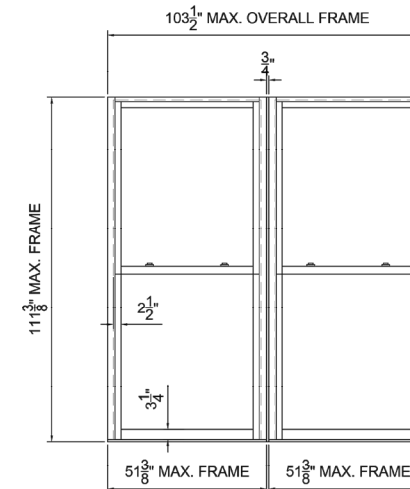

PART DESCRIPTION	SIZE
MAX. UNIT WIDTH	103 1/2"
MAX. UNIT HEIGHT	111 3/8"
STILES / TOP RAIL	2 1/2"
BOTTOM RAIL	3 1/4"
MAX. DESIGN PRESSURE	+47.0   -50.0

TRIPLE-HUNG SASH WEIGHT AND CHAIN WINDOWS

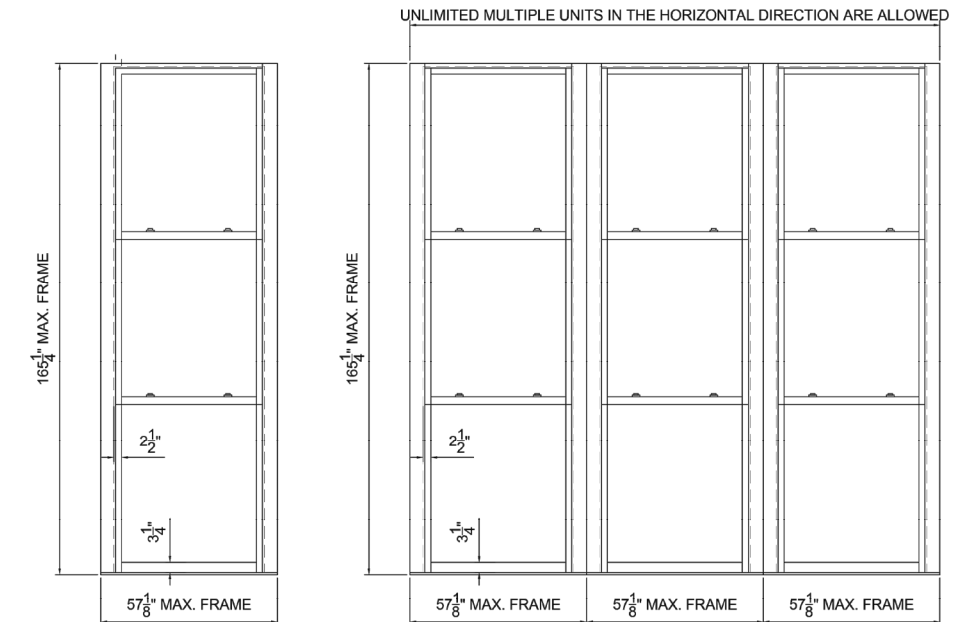

PART DESCRIPTION	SIZE
MAX. UNIT WIDTH	57 1/8"
MAX. UNIT HEIGHT	165 1/4"
STILES / TOP RAIL	2 1/2"
BOTTOM RAIL	3 1/4"
MAX. DESIGN PRESSURE	+70.0   -75.0

ANY AND ALL CONFIGURATIONS CAN BE MODIFIED TO MEET DESIGN INTENT

INSWING / OUTSWING  
12' DOUBLE DOOR

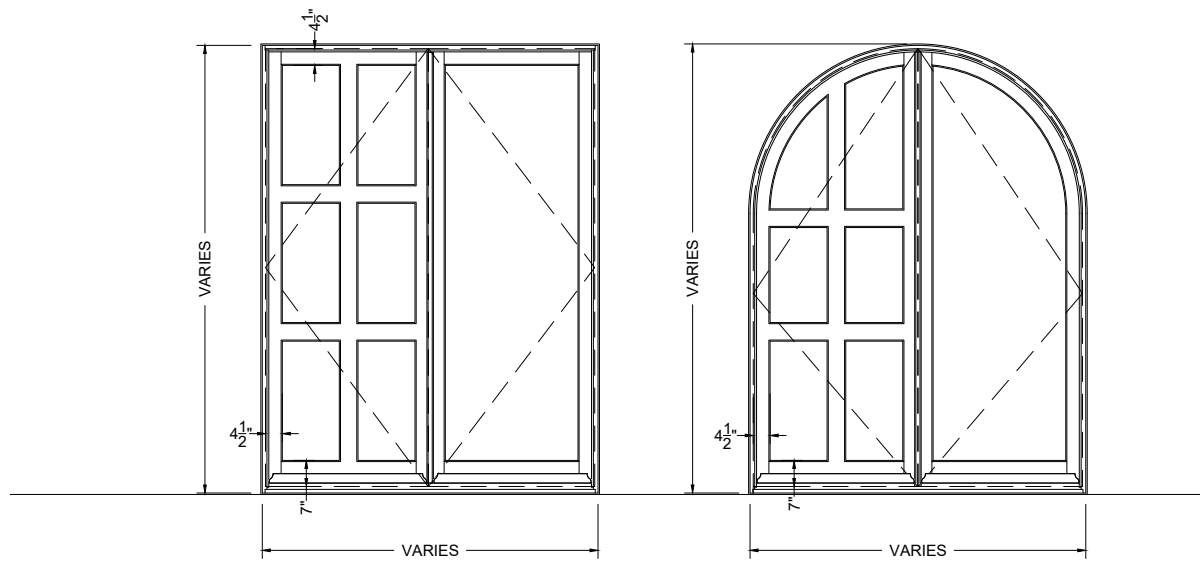

INSWING / OUTSWING  
12' SINGLE DOOR

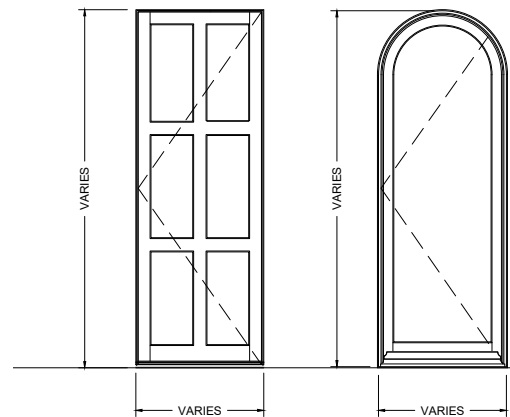

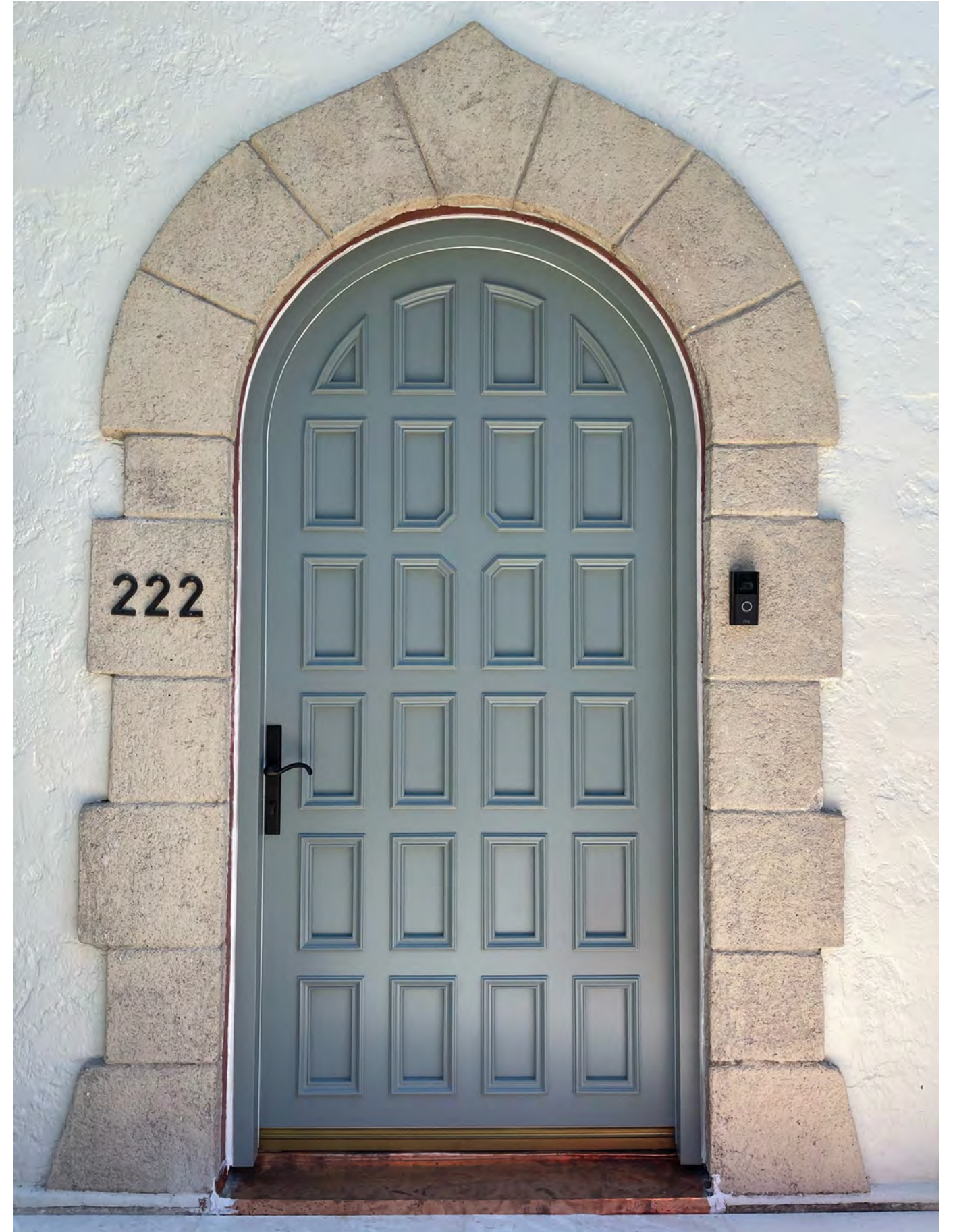
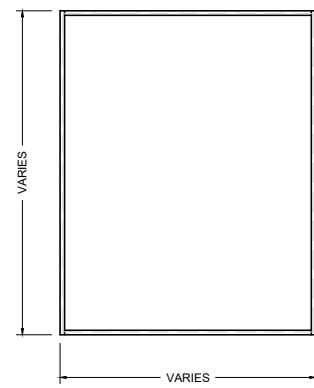

FIXED PICTURE FRAME WINDOW





## OPTIONS

### MATERIALS

- STAINLESS STEEL 316 
- GALVANIZED STEEL 
- ARCHITECTURAL BRONZE 

### THERMALLY BROKEN

- Available in Steel, Stainless Steel or Bronze
- Double or Triple weather-stripping gaskets
- Glazing bead options
- Narrow sightlines and durability
- Multipoint Hardware

### FINISHES

- Painted Powder Coated Finishes - Steel, Stainless Steel
- Artisan Finishes - Bronze (will Patina)
- RAL paint color options

### HARDWARE

- Siegenia Multi-Point Systems
- Multi-Point Gears
- Emtek
- FSB
- Fusital
- Hager
- McKinney
- Pemko
- Valli & Valli
- Sun Valley Bronze
- Merit
- Rocky Mountain Hardware
- Emtek
- FSB
- Fusital
- Hager
- Baldwin
- McKinney
- Rockwood
- Pemko
- FPL
- Valli & Valli

### GLAZING

Laminated Insulated Impact Glass  
 Annealed, High Strength, or Tempered  
 Possible Configurations: 3/16" or 1/4" x .075  
 or .090 x 1/2" Spacer x 3/16" or 1/4"

Mono Impact Glass  
 Annealed, High Strength, or Tempered  
 Possible Configurations: 3/16" or 1/4" x .075  
 or .090 x 1/2" Spacer x 3/16" or 1/4"  
 Other specs available, Low "E" options  
 available, Low iron glass available

Multiple glass configurations, colors and Low-E  
 films available. please contact Oliveri Millworks  
 for more details

\* Ballistic glass available, All colors available

\*Other Hardware brand options available, contact Oliveri Millworks for more options

## OLIVERI VS THEM

### OLIVERI: HOT ROLLED

SMALLER PROFILE

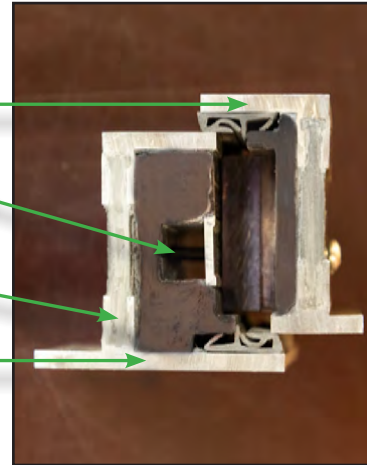

- Hot square edges
- Heavy FRP pultrusion house multi point
- Thermo Brake
- 4MM 316 Stainless
- Double Garnets

### THEM: COLD ROLLED

LARGER PROFILE

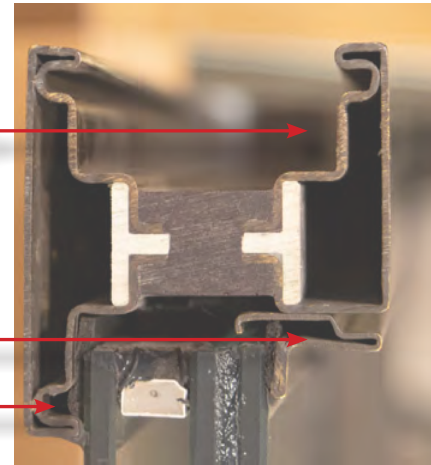

- 18 GAG Rolled Steel 304
- Flexible
- Rounded Edges

Same profile door or window for better look.

## HARDWARE ATTACHMENT

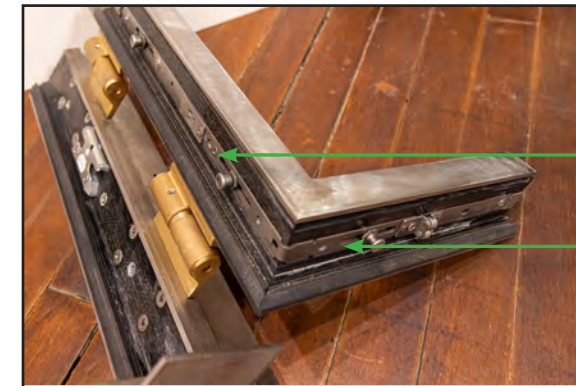

### OLIVERI:

- Full Multi Point Mounted in FRP Pultrusion Euro groove
- Bolted thru hardware - not screws that go out of adjustment

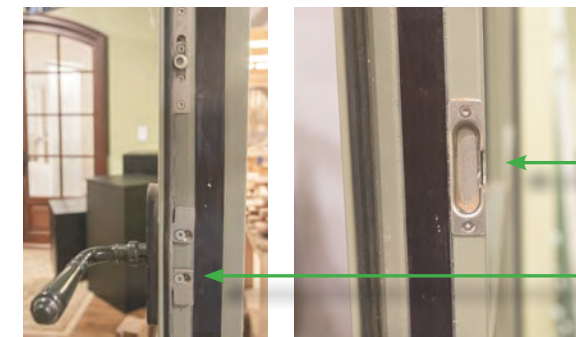

- Surface Mounted Hardware with IUO support

## HINGES

### OLIVERI: BRONZE

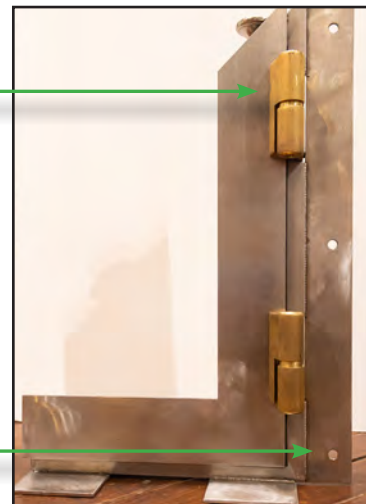

- Bronze Hinges Fully adjustable
- Nailing FIN for attachment or clips

### THEM: OVERSIZED NOT ADJUSTABLE



- Pot metal Not adjustable

## OWW - MA STAINLESS STEEL, BRONZE PROFILES

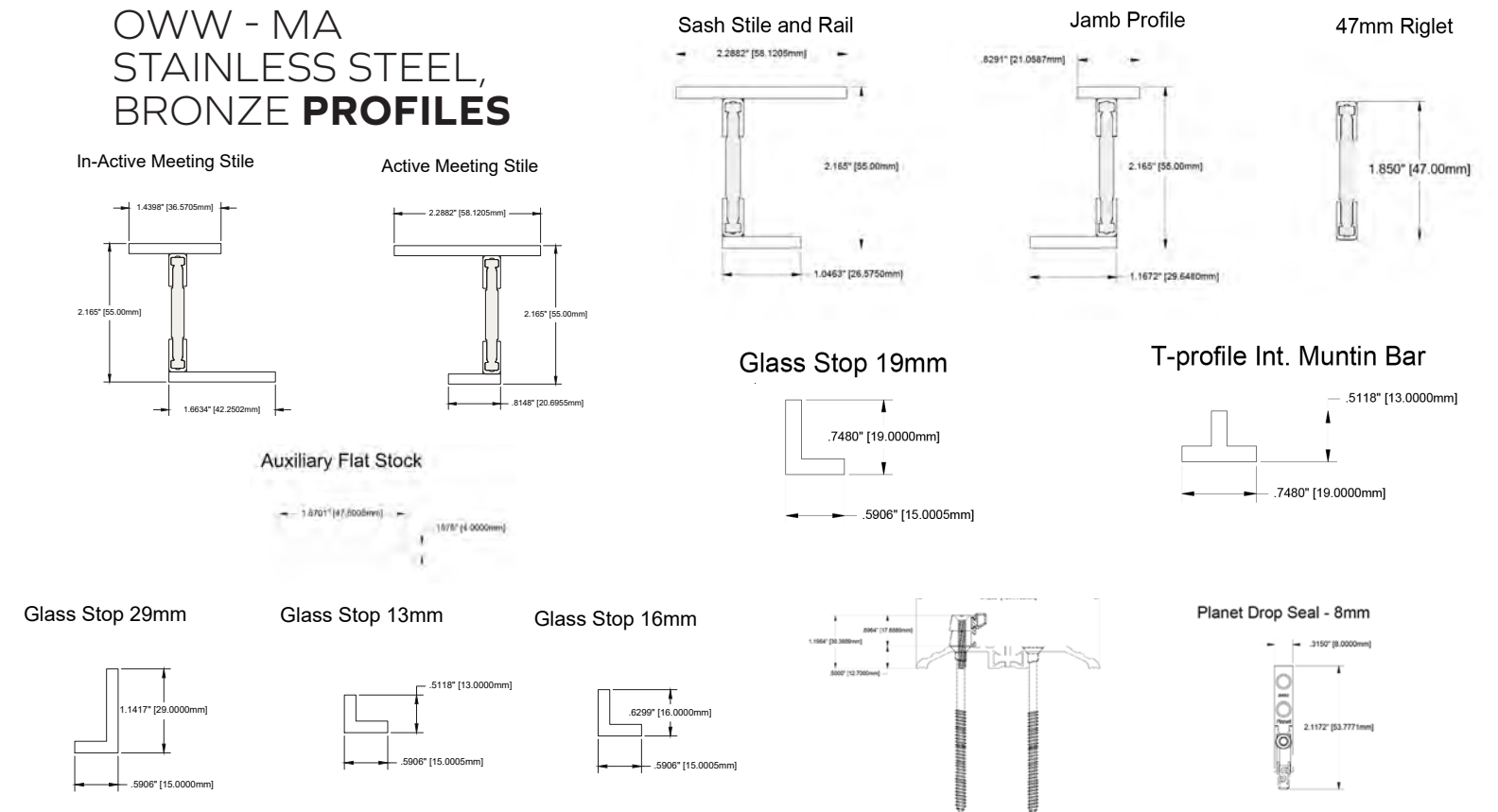

### OWW - MA Stainless Steel/Steel Profiles

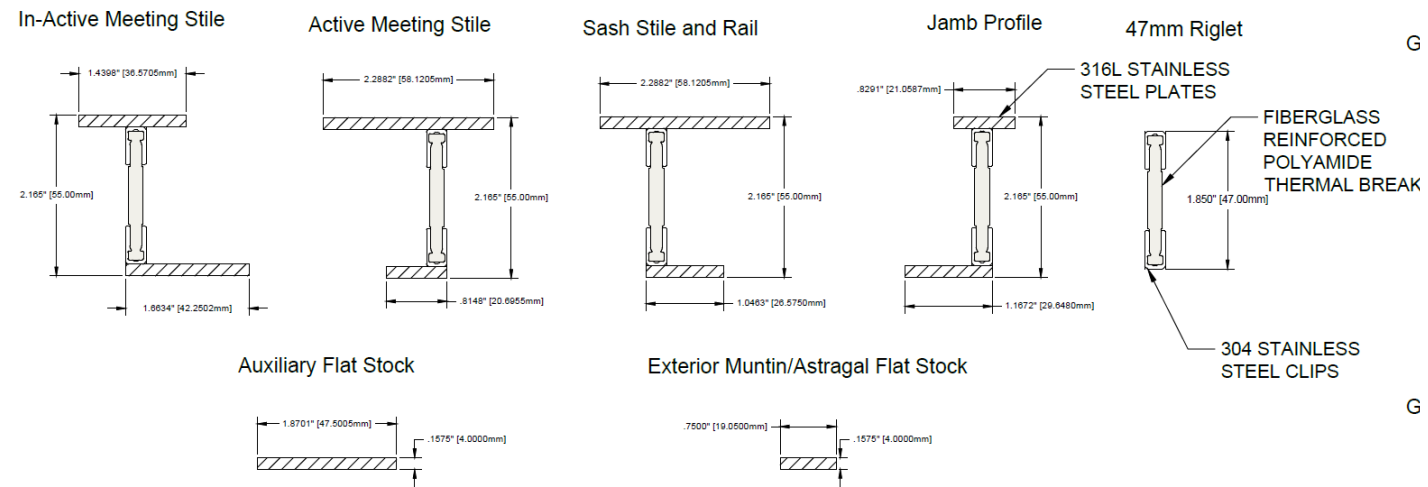

### OWW - MA Composite Infill Profiles

NOTE: ALL COMPOSITE MATERIAL IS FIBERGLASS REINFORCED PLASTIC

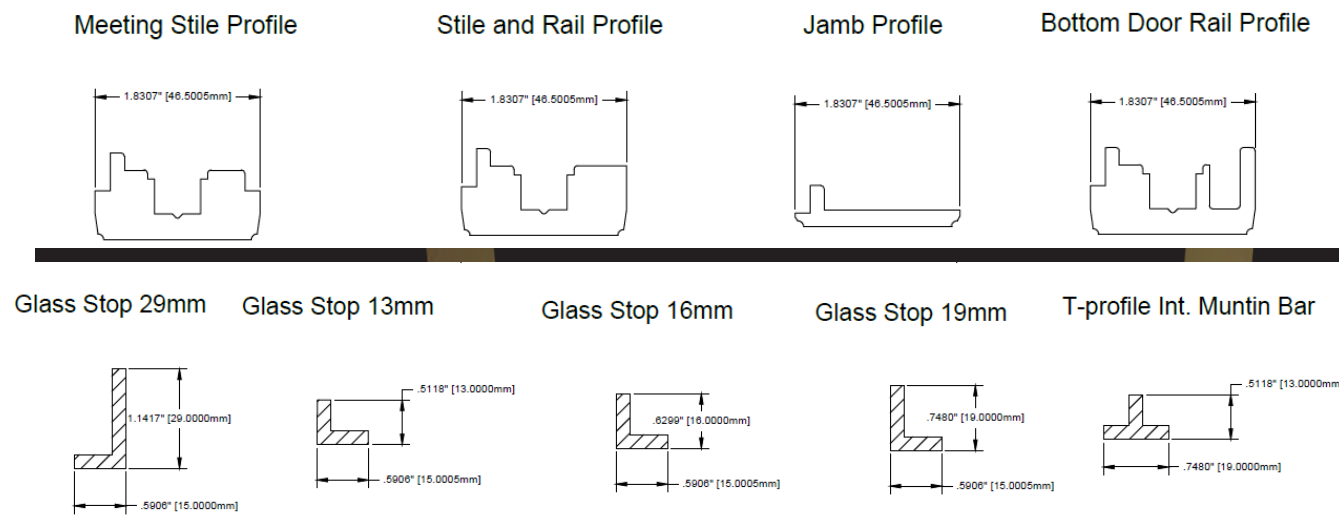

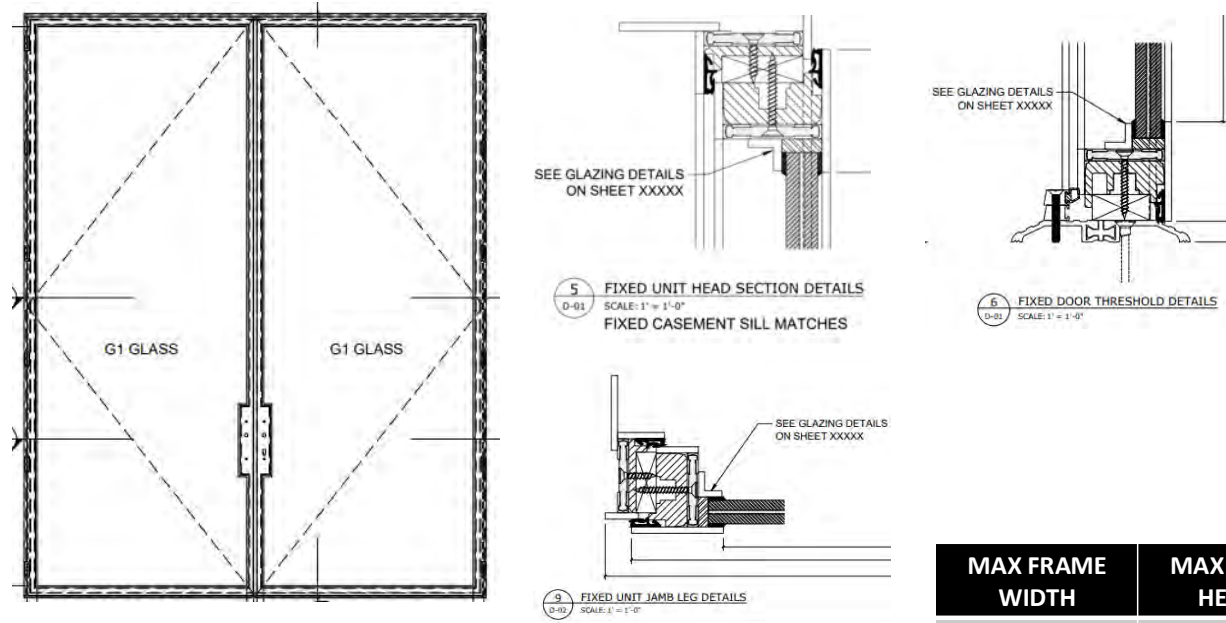

MAX FRAME WIDTH	MAX FRAME HEIGHT
132"	104 7/32"

APPLICATION DOORS    FIXED DOOR    VERSION 01

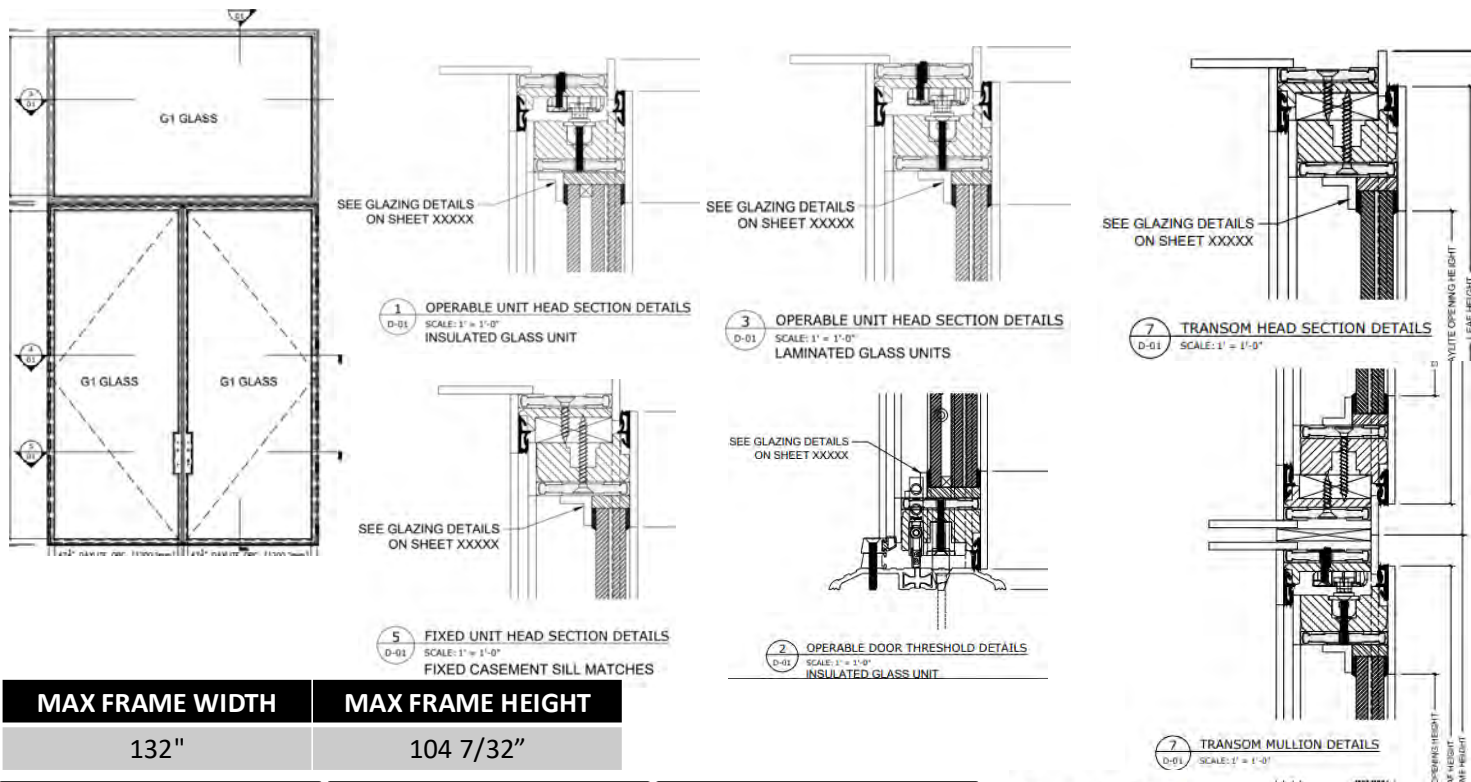

MAX FRAME WIDTH	MAX FRAME HEIGHT
132"	104 7/32"

APPLICATION DOORS    OUTSWING DOOR W/ FIXED TRANSOM    VERSION 01

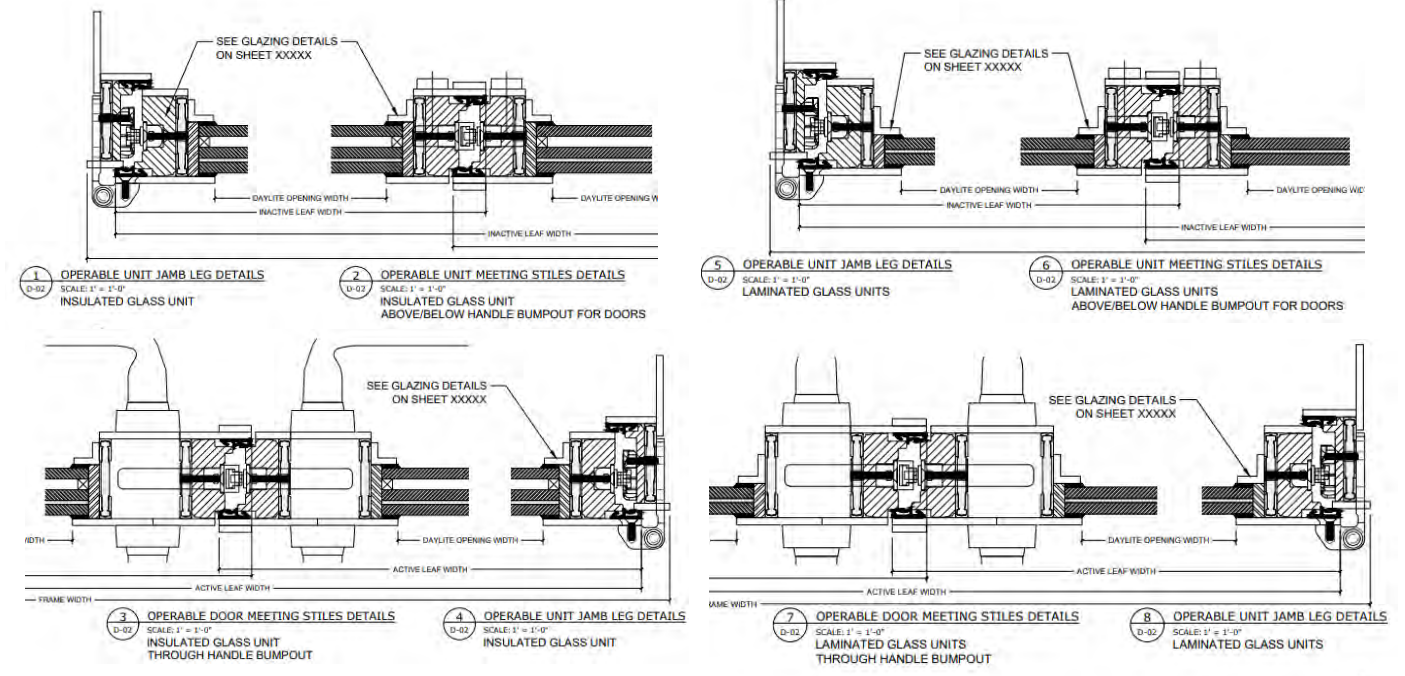

APPLICATION DOORS    OUTSWING DOOR W/ FIXED TRANSOM    VERSION 01





ANY AND ALL CONFIGURATIONS CAN BE MODIFIED TO MEET DESIGN INTENT

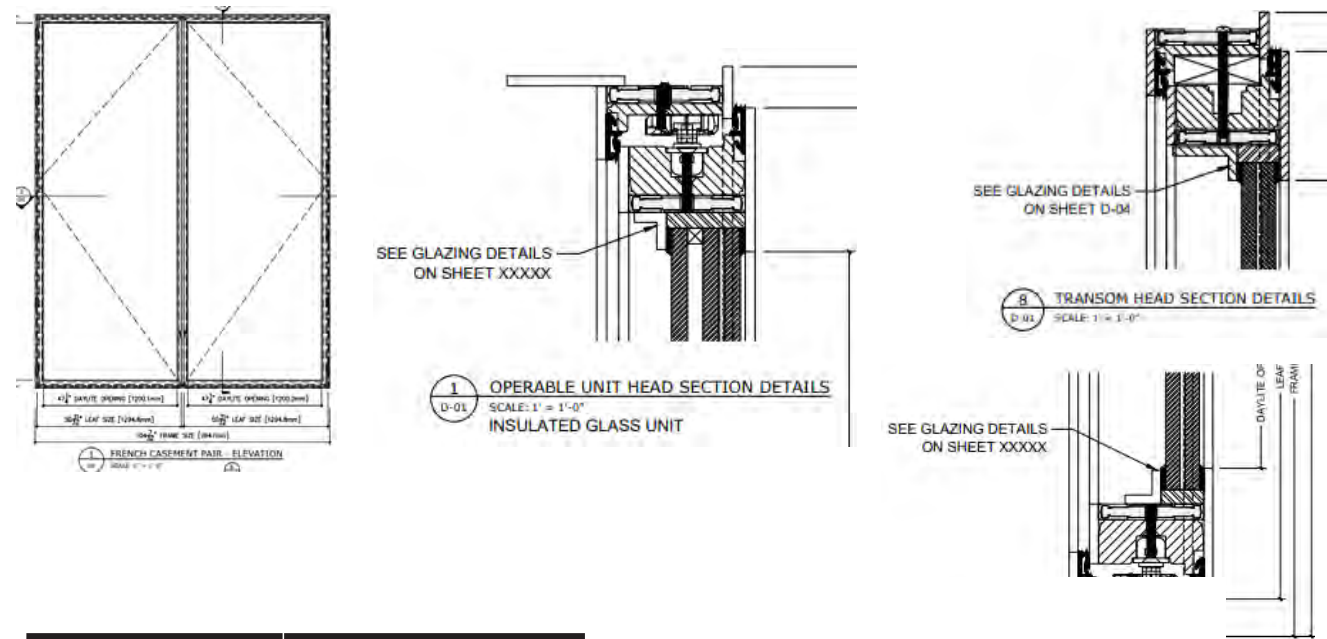

MAX FRAME WIDTH	MAX FRAME HEIGHT
132"	104 7/32"

CASEMENT WINDOWS	FRENCH CASEMENT	VERSION 01
------------------	-----------------	------------

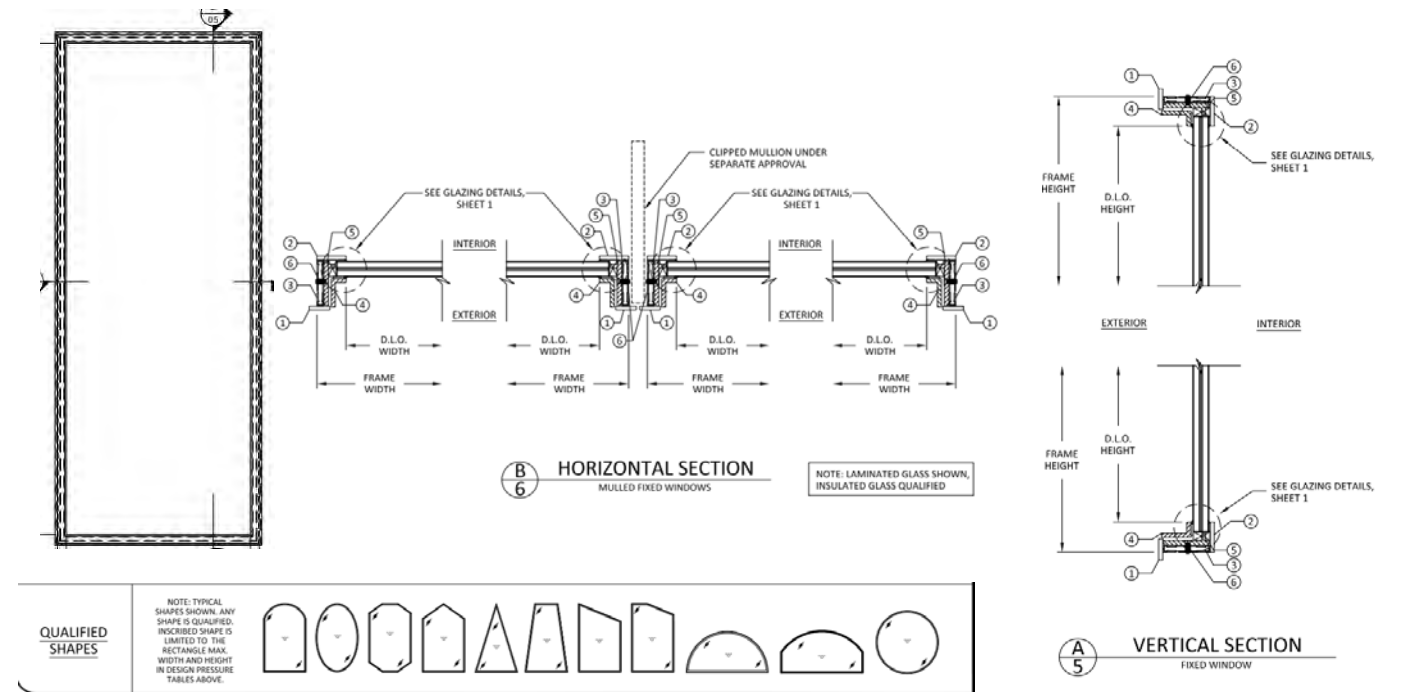

CASEMENT WINDOWS	FIXED DIRECT SET	VERSION 01
------------------	------------------	------------

OLIVERI  
ARCHITECTURAL  
WINDOWS + DOORS

OLIVERI  
ARCHITECTURAL  
WINDOWS + DOORS

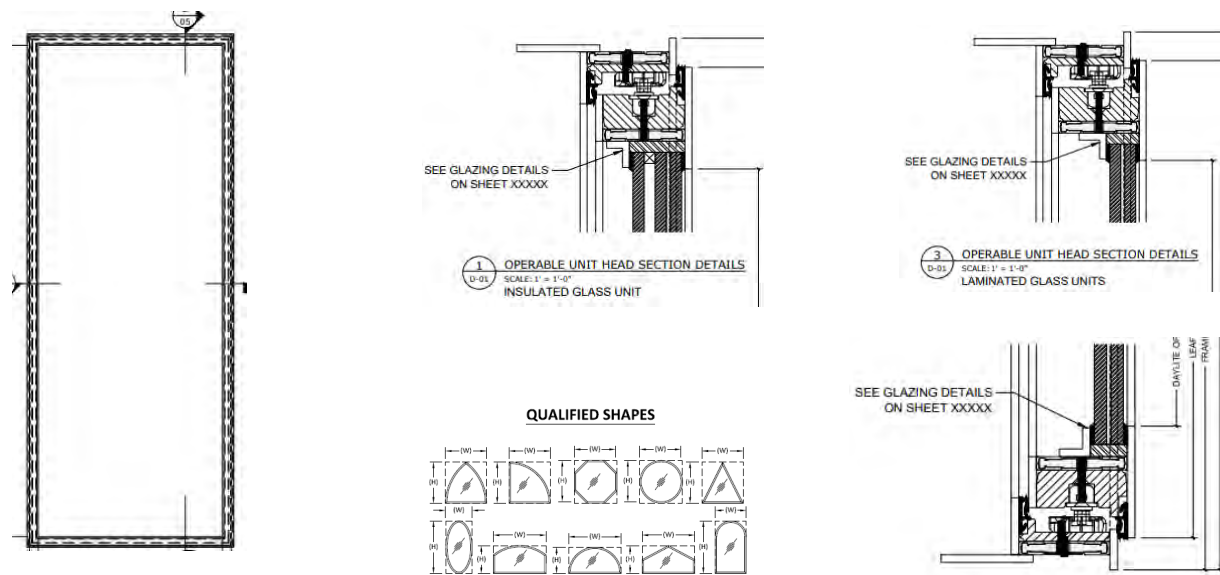

MAX FRAME WIDTH	MAX FRAME HEIGHT
53 1/8"	132"

CASEMENT WINDOWS	SINGLE CASEMENT	VERSION 01
------------------	-----------------	------------

OLIVERI  
ARCHITECTURAL  
WINDOWS + DOORS



ANY AND ALL CONFIGURATIONS CAN BE MODIFIED TO MEET DESIGN INTENT

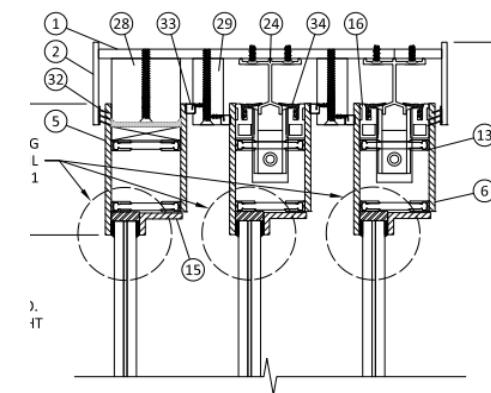

**A**  
**4** VERTICAL SECTION  
DOOR HEAD  
3-TRACK

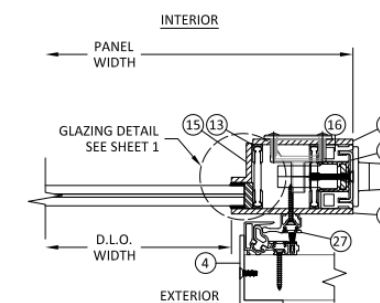

**H**  
**6** HORIZONTAL SECTION  
POCKET JAMB

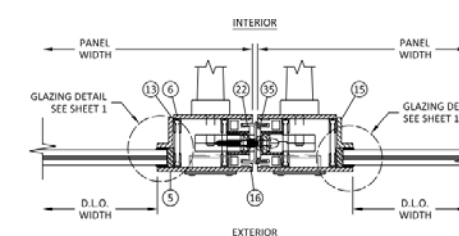
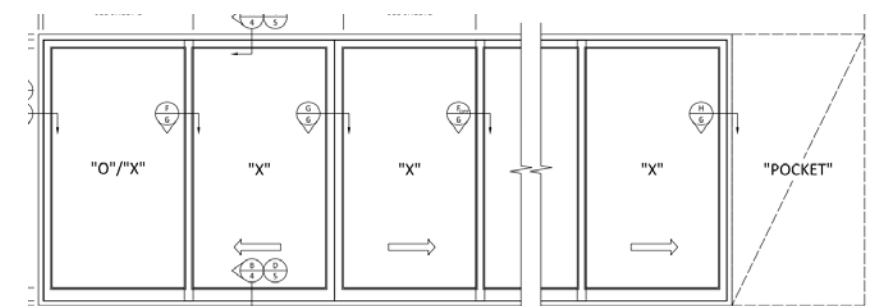

**G**  
**6** HORIZONTAL SECTION  
MEETING STILE

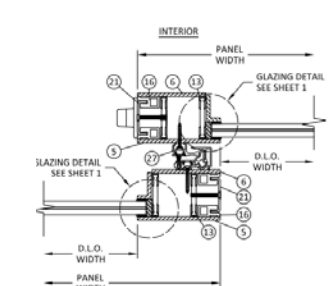

**F**  
**6** HORIZONTAL SECTION  
INTERLOCK

MAX PANEL SIZE	MAX FRAME HEIGHT
66 15/16" X 118 17/32"	122 3/16"

SLIDING EXTERIOR DOORS	LIFT & SLIDE	VERSION 01
------------------------	--------------	------------





# CUSTOM INTERIOR DOORS

## OPTIONS

### WOOD SPECIES

- Teak
- Exotic
- Cypress
- Red Oak
- White Oak
- Mahogany
- Old Growth Cypress
- Maple
- Painted Wood Doors Maple
- Wood Panel to be made MDF

### HARDWARE

- Siegenia Multi-Point Systems
- Multi-Point Gears
- Emtek
- FSB
- Fusital
- Hager
- McKinney
- Pemko
- Valli & Valli
- Sun Valley Bronze
- Merit
- Rocky Mountain Hardware
- Emtek
- FSB
- Fusital
- Hager
- Baldwin
- McKinney
- Rockwood
- Pemko
- FPL
- Valli & Valli

### GLAZING

Laminated Insulated Impact Glass  
 Annealed, High Strength, or Tempered  
 Possible Configurations: 3/16" or 1/4" x .075  
 or .090 x 1/2" Spacer x 3/16" or 1/4"

Mono Impact Glass  
 Annealed, High Strength, or Tempered  
 Possible Configurations: 3/16" or 1/4" x .075  
 or .090 x 1/2" Spacer x 3/16" or 1/4"  
 Other specs available, Low "E" options  
 available, Low iron glass available

Multiple glass configurations, colors and Low-E  
 films available. please contact Oliveri Millworks  
 for more details

\* Ballistic glass available, All colors available

\*Other Hardware brand options available, contact Oliveri Millworks for more options

### FINISHING

All Oliveri windows and doors are completely painted unassembled to allow for finishing in gasket  
 grooves and lock assembly areas, glazed, assembled and final coats are applied.

Oliveri Standard and Custom Colors Available



AVAILABLE PANEL OPTIONS

- A - Raised Panel
- B - Scoop Panel
- C - Flat Panel
- D - Double Hip Panel
- E - Senior Raised Panel
- OF - Senior Bevel Panel

AVAILABLE STICKING OPTIONS

- OG - Roman Ogee
- SS - Square Stick Sticking
- OS - One-Step Sticking
- QM - Quirk Moulding
- BV - Bevel Sticking
- CB - Cove & Bead Sticking
- TR - Traditional Sticking\*
- QB - Quarter Bead Sticking
- QR - Quarter Round Sticking
- BM - Bolection Moulding
- BBM - Big Bolection Moulding
- LP - Low Profile Bolection Moulding

# INTERIOR DOOR STYLES



OM1000



OM1010



OM1030



OM1050

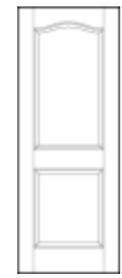

OM1040

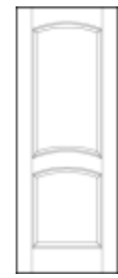

OM1050



OM1060



OM1070



OM2170

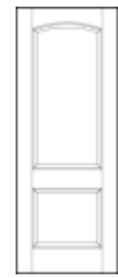

OM2180

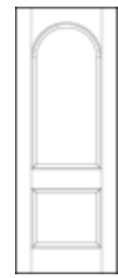

OM2190



OM2200

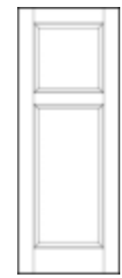

OM2250



OM2260



OM3000



OM3010



OM2000



OM2010



OM2020

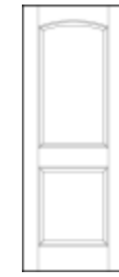

OM2030

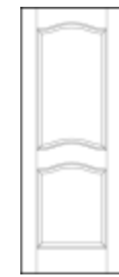

OM2080

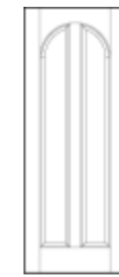

OM2090



OM2130

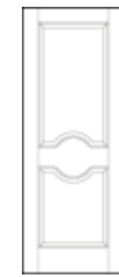

OM2160



OM2210

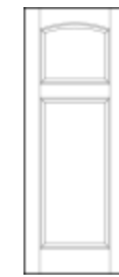

OM2220



OM2230



OM2240

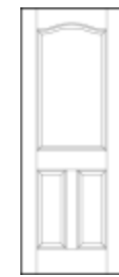

OM2250

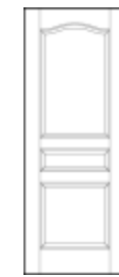

OM3030



OM3040

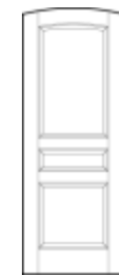

OM3050

# INTERIOR DOOR STYLES

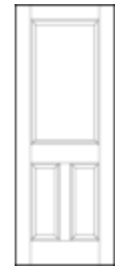

OM3060



OM3070



OM3080

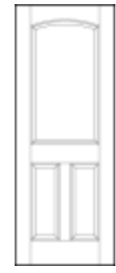

OM3090



OM3140



OM3150

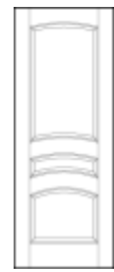

OM3160

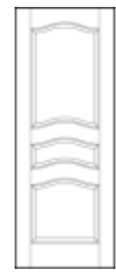

OM3170



OM3230



OM3240



OM3250

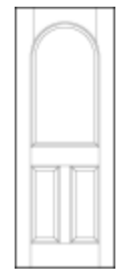

OM3260



OM3310

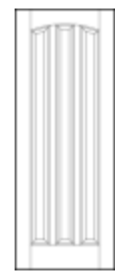

OM3320

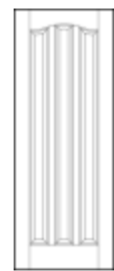

OM3330

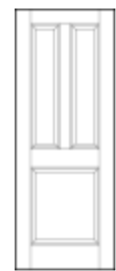

OM3340



OM3100

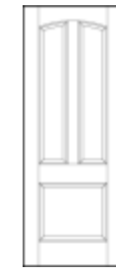

OM3110



OM3120



OM3130

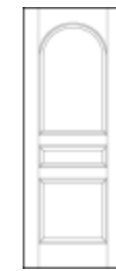

OM3180



OM3190



OM3210

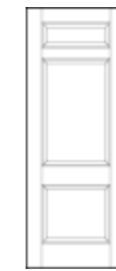

OM3220

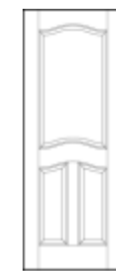

OM3270



OM3280



OM3290

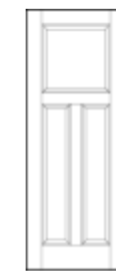

OM3300



OM3350



OM3360



OM3370



OM4000

# INTERIOR DOOR STYLES



OM4010

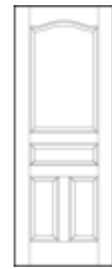

OM4020



OM4030

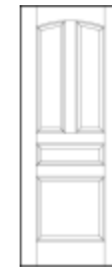

OM4040



OM4050



OM4060



OM4070



OM4100

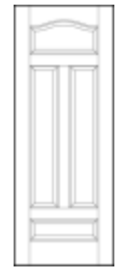

OM4110



OM4120

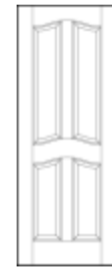

OM4130

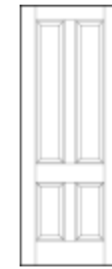

OM4140

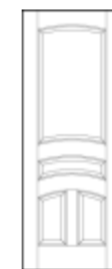

OM4150



OM4170



OM4190



OM4200



OM4210



OM4220

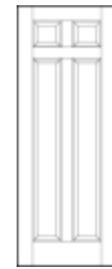

OM4230



OM4240



OM4250



OM4260



OM4270



OM4280

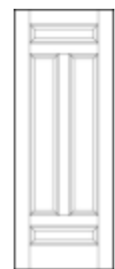

OM4290



OM4300

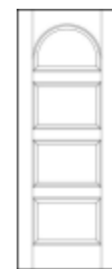

OM4310



OM5000

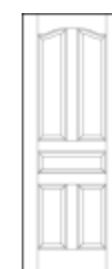

OM5010



OM5020



OM5030



OM5040

# INTERIOR DOOR STYLES



OM5050

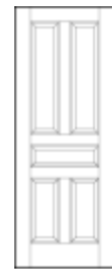

OM5060

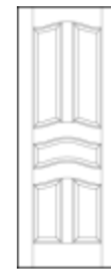

OM5070



OM5080

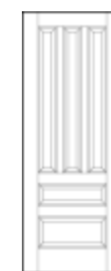

OM5090



OM5100



OM5110



OM5120



OM5130



OM5140

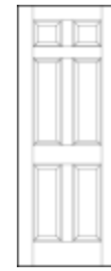

OM6000

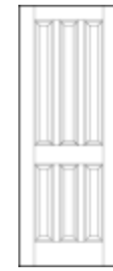

OM6010

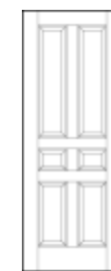

OM6020



OM6030



OM6040



OM6050



OM6070



OM6080

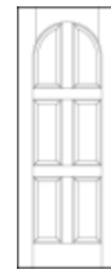

OM6090

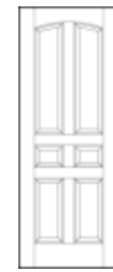

OM6100



OM6110



OM6120



OM6130



OM6140

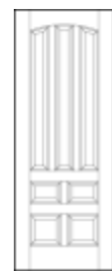

OM7000



OM7010

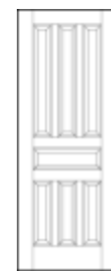

OM7020



OM8000



OM8010



OM8020



OM9000



OM9010

# CUSTOM EXTERIOR SHUTTERS

Custom exterior gates, doors, showers, fencing, pergolas, and trellises.



# GATES & STRUCTURES



# COMMERCIAL WINDOWS + DOORS

- Luxury Buildings
- Health Centers
- Country Clubs
- Hospitality
- Retail

- Steel Doors
- Metal Doors
- Fire Rated Doors
- Wood Interior Doors
- Exterior Impact Doors
- Exterior Impact Windows
- Luxury Hardware Brands



Automatic Entry Systems





OLIVERI  
ARCHITECTURAL  
WINDOWS + DOORS

MILLWORKS